

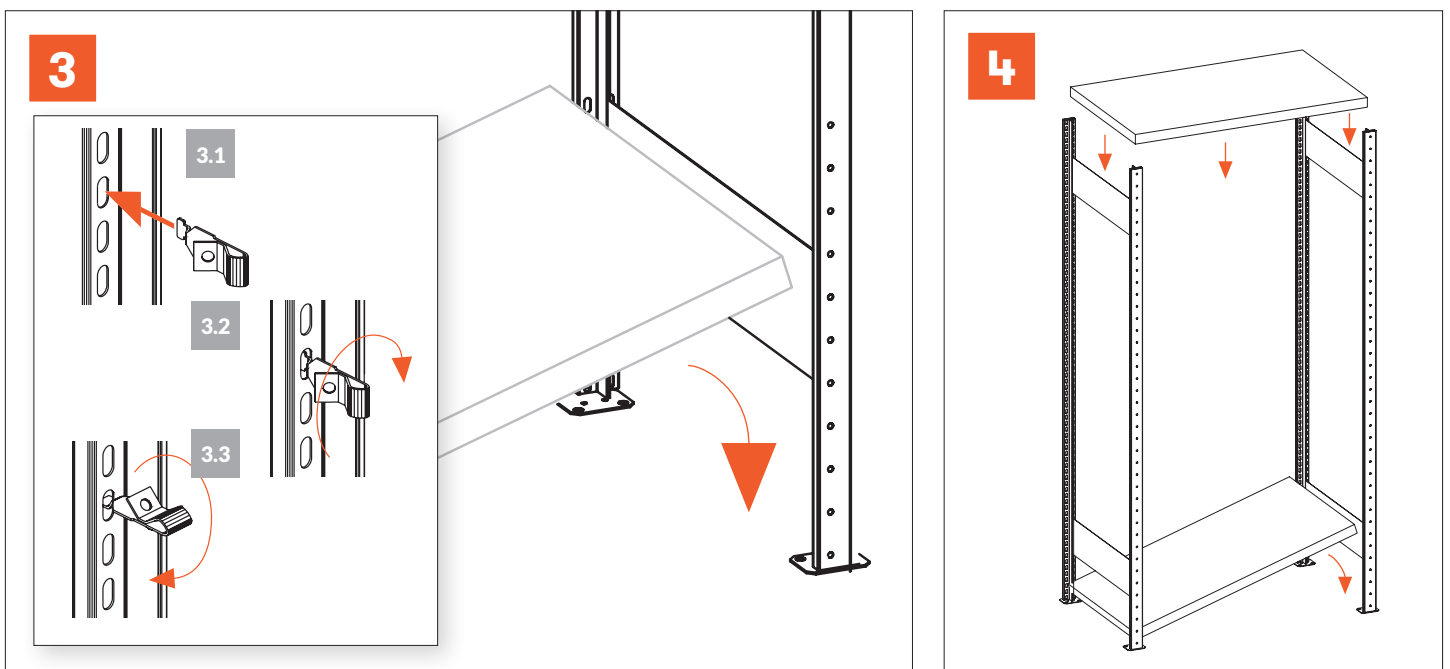

Montaje sin tornillos
Montage sans vis ni écrous
Aufbau ohne Schrauben

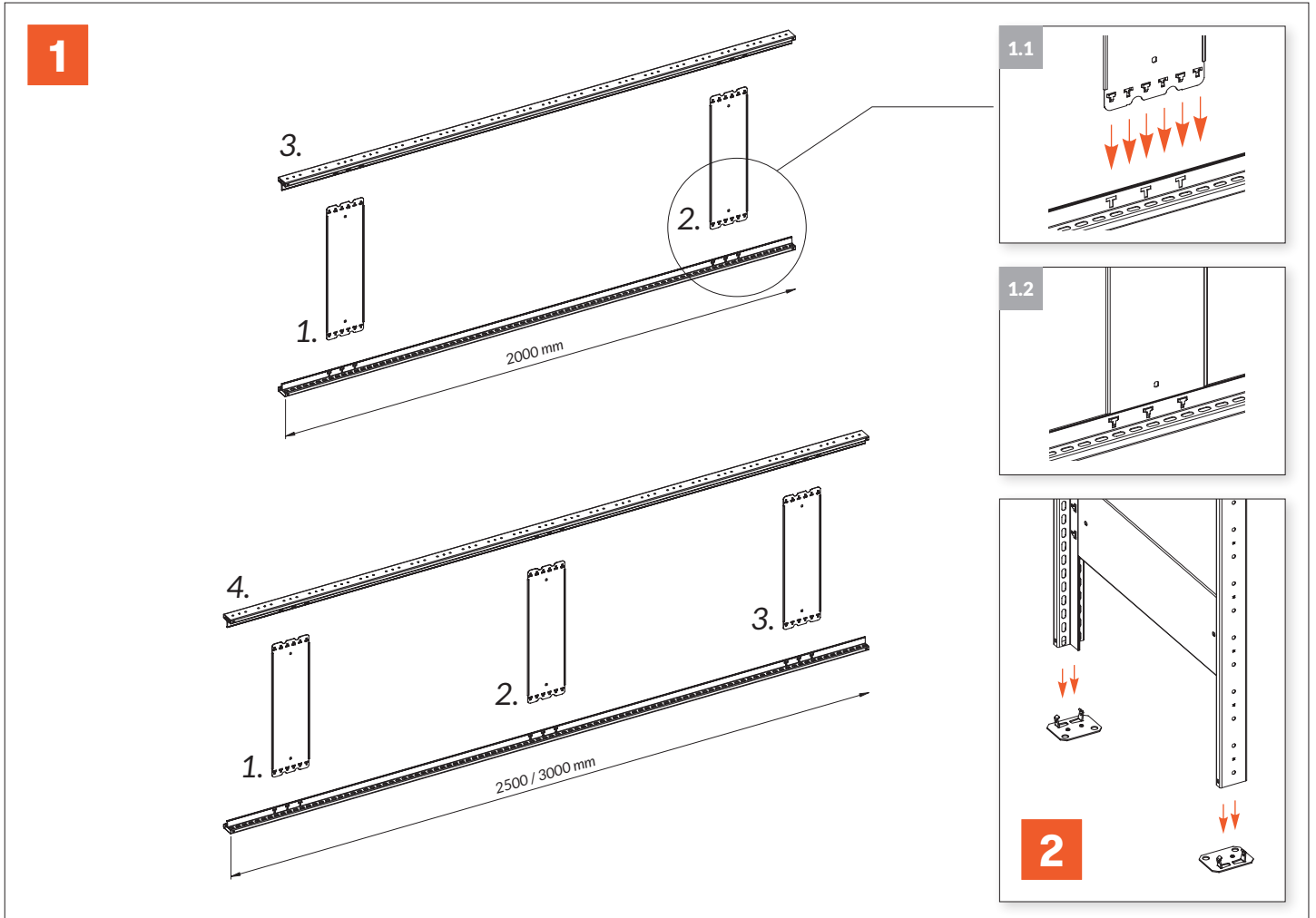

Se recomienda usar martillo de goma
Recommandé utiliser un marteau en caoutchouc
Empfohlen wird ein Gummihammer



5

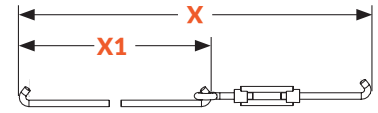
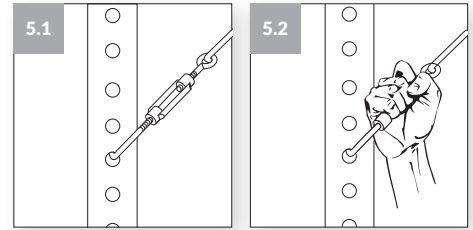
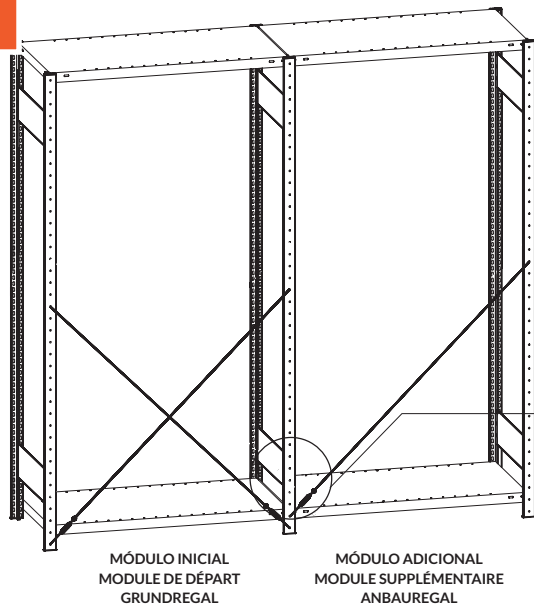

L	X	X1
1000 mm	1303 mm	1186 mm
1300 mm	1620 mm	1503 mm
1500 mm	1781 mm	1664 mm

B

(H) 2000 X
(L) 1000 / 1300 / 1500 mm

(H) 2500 / 3000 X
(L) 1000 / 1300 / 1500 mm

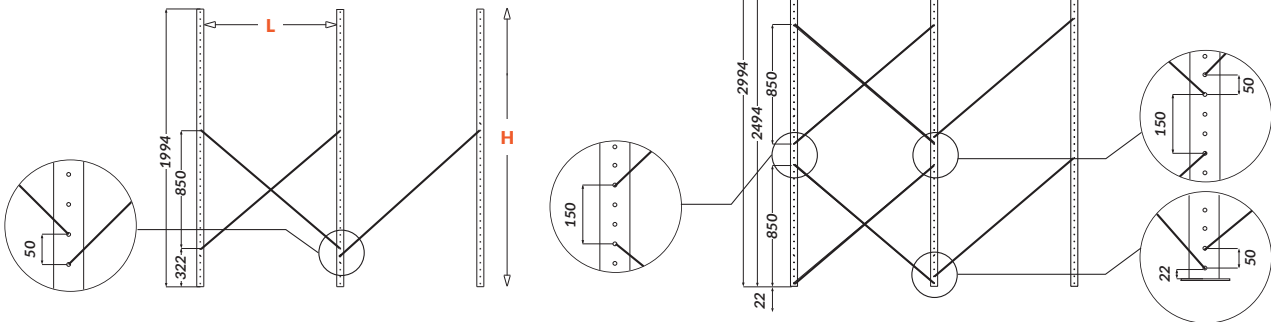

C

MÓDULO INICIAL
MODULE DE DÉPART
GRUNDREGAL

MÓDULOS ADICIONALES
MODULES SUPPLÉMENTAIRES
ANBAUREGALE

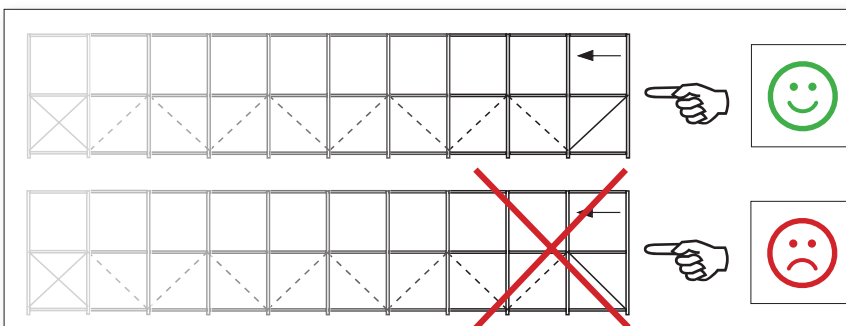
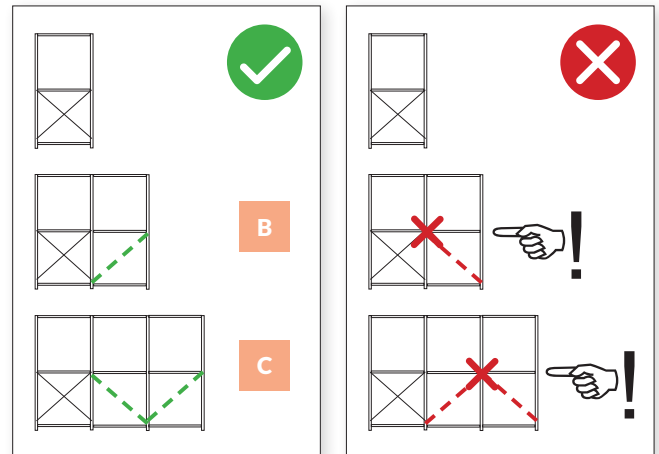
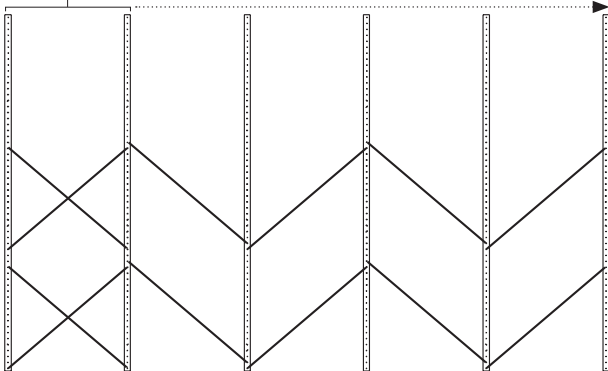

¡ATENCIÓN!
El tensor diagonal, siempre debe ir colocado de abajo a arriba en el último módulo adicional.

ATTENTION!
Le tenseur diagonal doit toujours être installé du bas vers le haut sur le dernier module supplémentaire.

ACHTUNG!
Die diagonale Verstrebung muß immer von unten nach oben im letzten Anbauregal angebracht werden.