

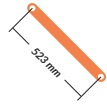

Necesario uso de llave fija del nº 10
Nécessaire utilisation d'une clef plate de 10
Verwendung Schraubenschlüssel Nr.10 notwendig

400 mm

FONDO - PROFONDEUR - TIEFE

H (mm)		
1950	3	3
2550	3	5
3000	3	6

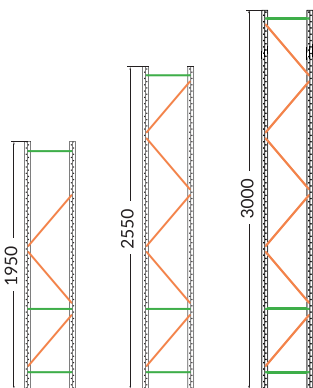
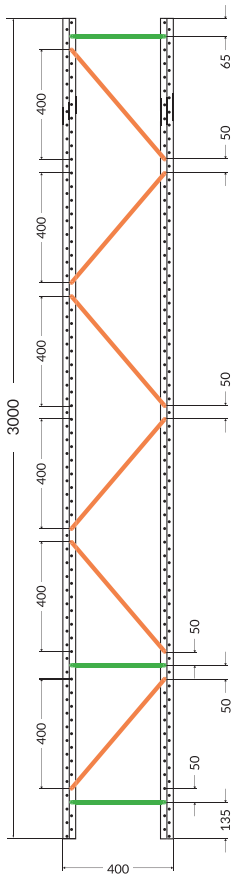

600 mm

FONDO - PROFONDEUR - TIEFE

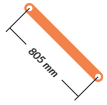
H (mm)		
1950	3	2
2550	4	3
3000	4	4

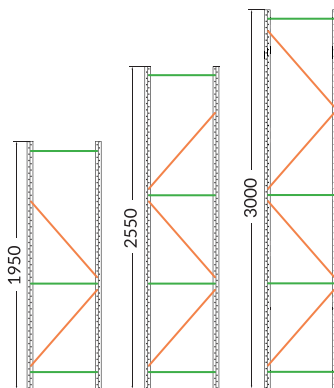
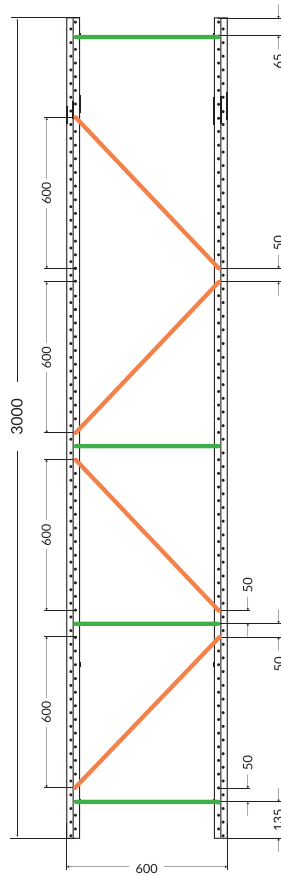

800 & 1000 mm

FONDO - PROFONDEUR - TIEFE

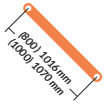
H (mm)		
1950	3	2
2550	4	3
3000	4	3

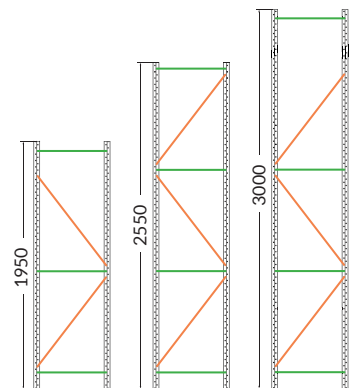
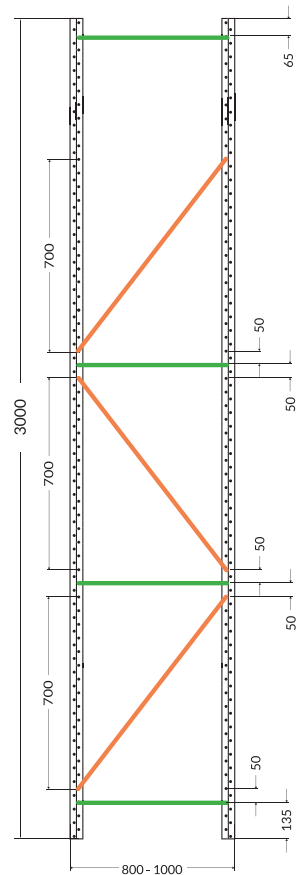

1

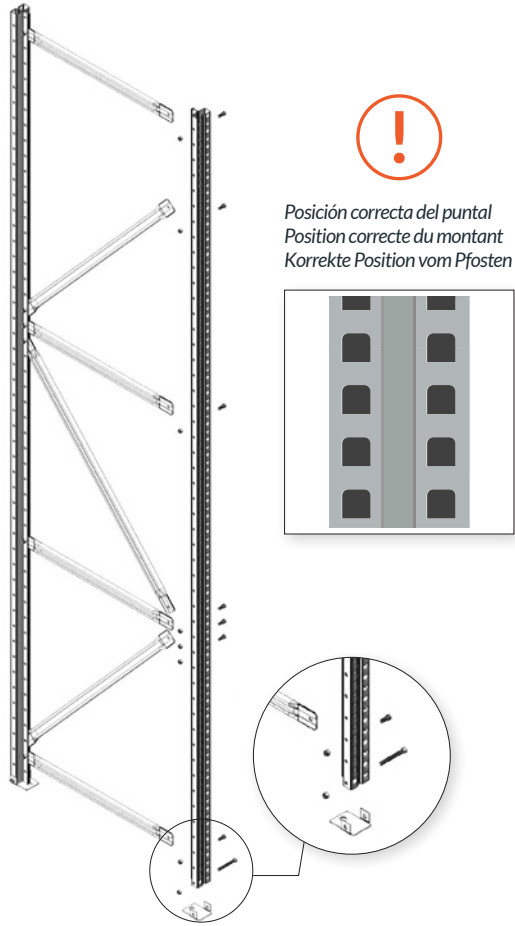

2

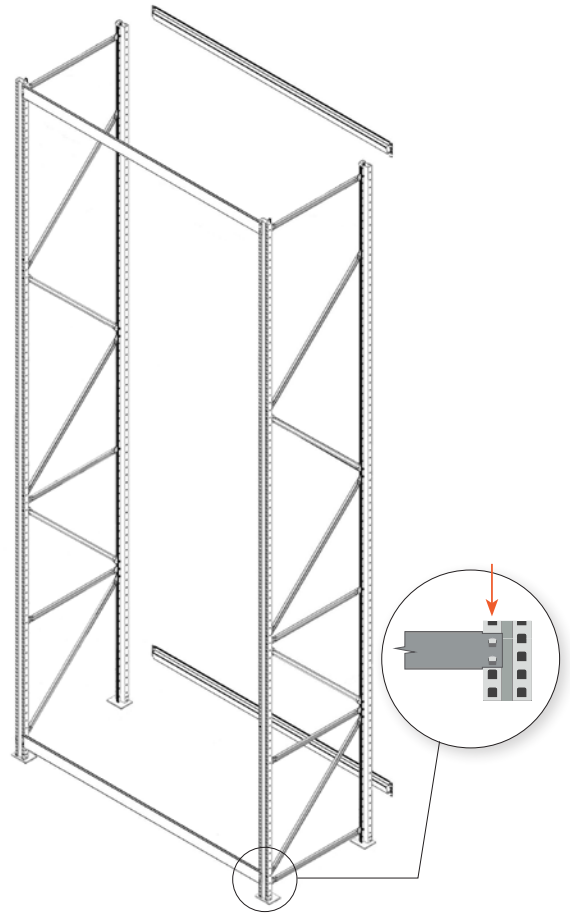

3

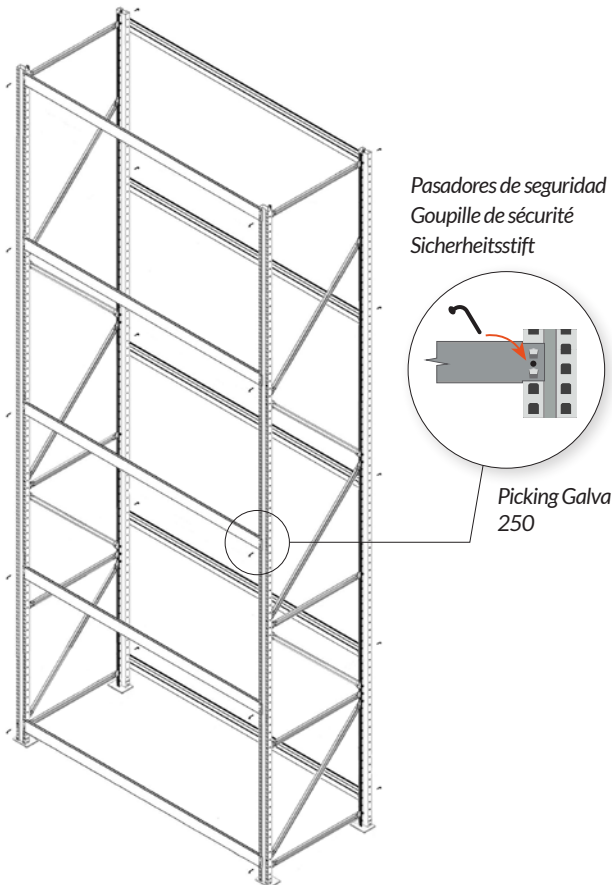

4

